



Behavioral Healthcare Solutions

by BEST



TABLE OF CONTENTS

Introduction.....	2	SPSL Tubular functions.....	7
Vertical market application example.....	2	SPSL Tubular How to orde.....	7
SPSL Mortise features.....	3	SSRL introduction & features.....	8
SPSL Mortise functions.....	4-6	SEDA introduction.....	9
SPSL Mortise how to order.....	6	SEDA typical installations.....	9
SPSL Tubular features.....	7	SEDA elements.....	10-11

Introduction

dormakaba is pleased to offer the BEST behavioral healthcare solutions product portfolio. Facilities are challenged with maintaining a delicate balance of patient safety and security. The behavioral healthcare solutions portfolio provides a comprehensive breadth of products designed to meet these unique application challenges.

While no product can ever replicate the effectiveness of constant patient monitoring, we strive to present the most effective door locks, alarms and related hardware to assist facility staff in ensuring patient safety. Through close collaboration with behavioral healthcare professionals, BEST has become the single source for the most up-to-date behavioral healthcare door safety solutions.

Specifications are subject to change. To ensure proper code compliance please consult the local AHJ - Authority Having Jurisdiction.

Vertical Market Application Example: Behavioral Healthcare Facility

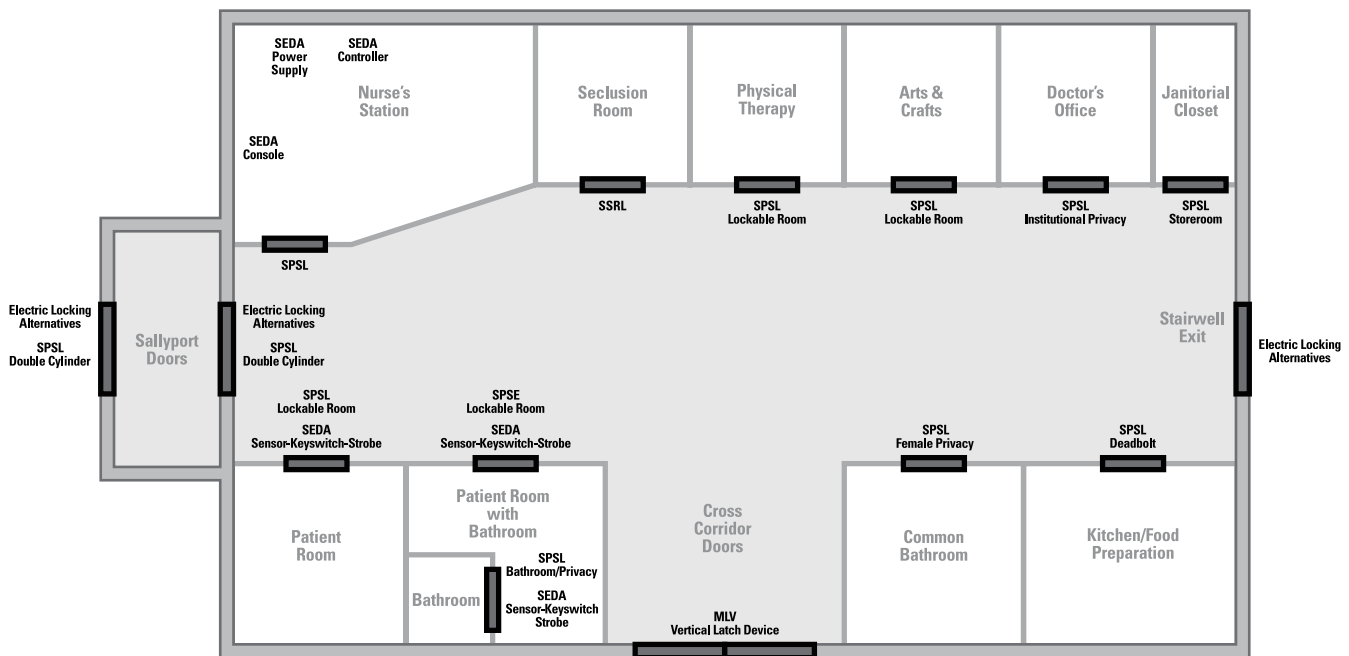

SPSL – Secure Patient Safety Lever: Mortise

Secure Patient Safety Lever (SPSL) meets the needs of resisting ligature engagement on the lock trim while providing patients and staff with easy-to-operate hardware. The patentpending design meets the intent of ADA (Americans with Disabilities Act) by eliminating the operational requirement "pinch & grasp" motion. The reliable performance and security found within the traditional BEST products is now available in an anti-ligature design.

The tight tolerances, smooth meshing of the lever and the non-moving conical lock escutcheon set the industry standard. As an added suicide resistant measure, the lever is always free-moving bi-directionally, regardless of the lock function. The solid stainless steel design represents the highest level of quality construction found in the industry.

A wide variety of locking needs are met by the different mortise lock functions.

Innovative Ligature-Resistant Features

Designed in collaboration with the nation's largest behavioral healthcare service providers and industry consultants

- Independent, tapered, bidirectional lever
- Thru-bolted fixed conical escutcheon
- Low profile off the door

Durable Design

Proven performance on thousands of applications

- Independent lever springs in escutcheon
- Lever movement stops within escutcheon
- Stainless steel escutcheon and lever
- Fewer moving parts
- Accommodates 1 3/4" door thickness

Customer-Driven Functions

SPSL locksets meet the unique needs of the various spaces within a secured behavioral ward

- **Patient Room** - Allows locking patient "out-of-room" and then converting to passage for other times. Free egress at all times.
- **Key Only Entry** - Key required at all time (storeroom), with anti-ligature levers. Free egress at all times.
- **Privacy** - Unique patent pending turnpiece design with traditional privacy anti-lockout function (including coin-turn cylinder for emergency entry)

More industry - driven functions than any other lockset; See pages 4, 5, and 6.

"State-Of-The-Art" Electrified Series

Available for use on doors that need to be electrified within the behavior health unit.

SPSE - Fail-secure (electrically unlocked) on the exterior; free egress at all times.

SPSF - Fail-safe (electrically locked) on the exterior; free egress at all times.

SPS3 - Fail-secure on both sides.

SPS4 - Fail-safe on both sides.

Optional signaling options include request-to-exit, door position and latch position switches, all of these can be monitored via an access control system.-



Passage



Security



Deadbolt

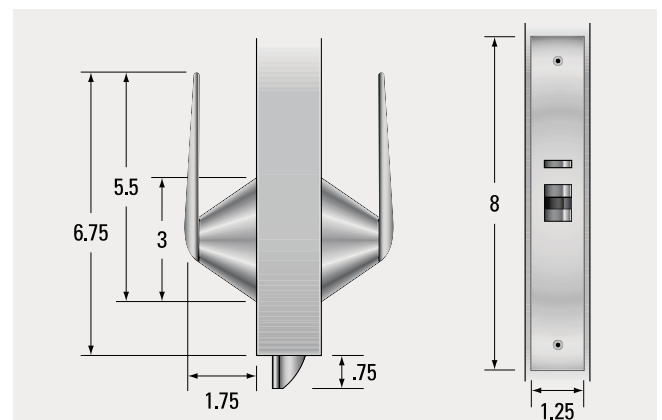

SPSL – Mortise Lock Functions

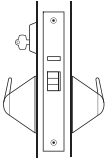
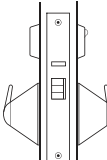
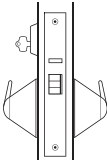
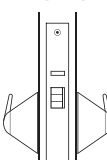
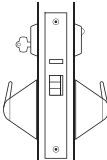
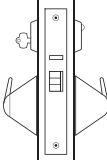
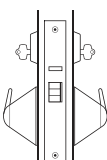
Nomenclature	Behavioral Healthcare Function (Popular usage)	BEST # & Nearest ANSI equivalent	Cylinders	Latch operated by	Element & operating information		
					Outside lever	Interior locking	Inside lever
Keyed - most popular							
SPSL-ML-R-16F 	Lockable Patient Room	R-Classroom F05	1	Rotating inside lever Rotating outside lever only when unlocked by key	Lockable		Cannot be locked
SPSL-ML-LT-16F 	Bathroom/Privacy	LT-Bathroom Privacy	Special	Emergency entry via coin-turn cylinder Free egress at all times Anti-lockout feature*	Lockable	Turnpiece	Cannot be locked
SPSL-ML-D-16F 	Keyed entry	D-Storeroom F07	1	Key always required for entry Free egress at all times Exterior lever push/pull only	Dummy		Cannot be locked
Keyless							
PSL-ML-ON-16F 	Passage	ON-Passage F01	0	Rotating inside OR outside lever at any time	Cannot be locked		Cannot be locked
Keyed - single & double cylinder							
SPSL-ML-RF-16F 	Bedroom Privacy	RF Bedroom Privacy	1	Rotating outside lever only when unlocked by key Rotating inside lever Free egress at all times Remains locked upon exiting	Lockable	Turnpiece	Cannot be locked
SPSL-ML-LTF-16F 	Bedroom Privacy	LTF Bedroom Privacy	1	Rotating outside lever only when unlocked by key Rotating inside lever Free egress at all times Anti-Lockout feature remains	Lockable	Cannot be locked	Cannot be locked
SPSL-ML-INL-16F 	Lockable double cylinder	INL-Intruder F32	2	Cylinder on exterior OR interior activates/deactivates exterior lever. Free egress at all times	Lockable	Cylinder	Cannot be locked

NOTES: Locked lever is always free-moving, but does not retract latch when "locked". Latchbolt deadlocked by auxiliary latch. Passage, privacy, and deadbolt models do not contain auxiliary deadlatch. Turnpiece, when used, is anti-ligature design. Coin-turn cylinder is openable without use of a key.

SPSL – Mortise Lock Functions

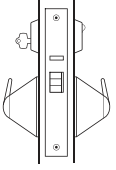
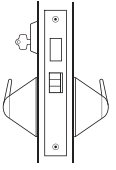
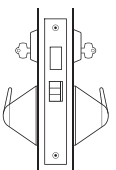
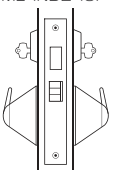
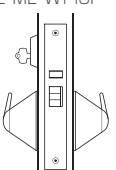
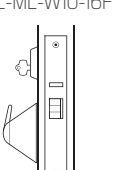
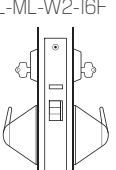
Nomenclature	Behavioral Healthcare Function (Popular usage)	BEST # & Nearest ANSI equivalent	Cylinders	Latch operated by	Element & operating information		
					Outside lever	Interior locking	Inside lever
Keyed - single & double cylinder							
SPSL-ML-A-16F 	Office/privacy	A-Office Institutional privacy F26	1	Exterior cylinder OR interior cylinder Pressing the inside lever down allows free exiting from the room and reactivates the outside lever.	Lockable	Turnpiece	Cannot be locked
SPSL-ML-T-16F 	Deadbolt	T-Dormitory deadbolt F13	Special	Key projects deadbolt Exterior lever retracts latch Interior lever retracts latch and deadbolt*	Operable except when deadbolted		Cannot be locked
SPSL-ML-IND-16F 	Deadbolt double cylinder	IND-Intruder deadbolt F33	2	Exterior OR interior key projects deadbolt Exterior lever retracts latch Interior lever retracts latch and deadbolt*	Operable except when deadbolted	Cylinder	Cannot be locked
PSL-ML-IND2-16F 	Keyed only deadbolt & latch	IND2-Storeroom deadbolt	2	Exterior OR interior key projects deadbolt Exterior OR interior key retracts latch and deadbolt	Dummy	Cylinder	Dummy
Asylum - no free egress							
SPSL-ML-WI-16F 	Asylum	WI-Asylum	1	Only exterior key retracts latch	Dummy		Dummy
SPSL-ML-WIO-16F 	Asylum No interior lever	WIO-Asylum	1	Exterior key retracts latch	Dummy		None
SPSL-ML-W2-16F 	Asylum Double cylinder	W2-Asylum F30	2	Exterior OR interior key retracts latch	Dummy	Cylinder	Dummy

NOTES: Locked lever is always free-moving, but does not retract latch when "locked". Latchbolt deadlocked by auxiliary latch. Passage, privacy, and deadbolt models do not contain auxiliary deadlatch. Turnpiece, when used, is anti-ligature design. Coin-turn cylinder is openable without use of a key.

SPSL – Mortise Lock Functions

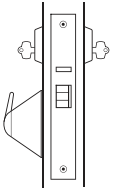
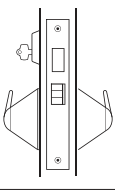
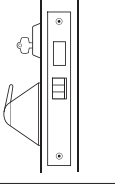
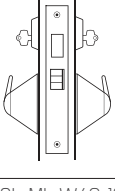
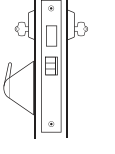
Nomenclature	Behaviorial Healthcare Function (Popular usage)	BEST # & Nearest ANSI equivalent	Cylinders	Latch operated by	Element & operating information		
					Outside lever	Interior locking	Inside lever
Asylum - no free egress (continued)							
SPSL-ML-W20-16F 	Asylum Double cylinder No interior lever	W20-Asylum F30	2	Exterior OR interior key retracts latch	Dummy	Cylinder	None
SPSL-ML-W3-16F 	Asylum With deadbolt	W3-Asylum Deadbolt	1	Exterior lever retracts latch Deadbolt operated by key	Cannot be locked		Dummy
SPSL-ML-W30-16F 	Asylum With deadbolt No interior lever	W30-Asylum Deadbolt	1	Exterior lever retracts latch Deadbolt operated by key	Operable except when deadbolted		None
SPSL-ML-W4-16F 	Asylum With deadbolt Double cylinder	W4-Asylum Deadbolt	2	Exterior OR interior key operation Levers retract latch, not deadbolt Exterior OR interior key operates deadbolt	Operable except when deadbolted	Cylinder	Operable except when deadbolted
SPSL-ML-W40-16F 	Asylum With deadbolt Double cylinder	W40-Asylum Deadbolt	2	Exterior OR interior key operation Exterior OR interior key operates deadbolt	Operable except when deadbolted	Cylinder	None

NOTES: Locked lever is always free-moving, but does not retract latch when "locked". Latchbolt deadlocked by auxiliary latch. Passage, privacy, and deadbolt models do not contain auxiliary deadlatch. Turnpiece, when used, is anti-ligature design. Coin-turn cylinder is openable without use of a key.

How To Order

SPSL	ML	R		16F	630	RH*	SH
Series	Chassis	Function		Lever	Finish	Hand	Options
SPSL – Secure Patient Safety Lever	ML – Mortise	A – Office privacy	W3 – Asylum deadbolt lever/lever	16F – Anti-ligature lever	630 – Satin stainless steel	RH LH RHRB LHRB	SH – Includes security head screws
		D – Storeroom	W4 – Asylum deadbolt double cyl lever/lever				
		IND – Intruder deadbolt	W10 – Asylum lever blank				
		IND2 – Intruder storeroom deadbolt	W20 – Asylum double cyl lever/blank				
		INL – Intruder latch	W30 – Asylum deadbolt lever/blank				
		LT – Bathroom privacy	W40 – Asylum lever/blank				
		R – Classroom					
		T – Dormitory deadbolt					
		W1 – Asylum lever/lever					
		W2 – Asylum double cyl lever/lever					

To ensure proper code compliance, please consult the local AHJ - Authority Having Jurisdiction. *Handed, not field reversible

How To Order

SPSE	ML	RDL		630	RH*	SH
Series	Chassis	Function		Finish	Hand	Options
SPSE – Fail-Secure Exterior Only	ML – Mortise	NNN – No Signaling Options	NDN – DPS	630 – Satin stainless steel	RH	SH – Includes security head screws
SPSF – Fail-Safe Exterior Only		RDL – REX; DPS; LPS	RDN – REX; DPS		LH	
SPS3 – Fail-Secure Both Sides		NDL – DPS; LPS	RNL – REX; LPS		RHR	
SPS4 – Fail-Safe Both Sides		NNL – LPS	RNN – REX		LHR	

*Handed, not field reversible

REX = Request-To-Exit

DPS = Door Position Switch

LPS = Latch Position Switch

SPSL – Secure Patient Safety Lever: Cylindrical

Secure Patient Safety Lever (SPSL) meets the needs of resisting ligature engagement on the lock trim while providing patients and staff with easy-to-operate hardware. The patent-pending design meets the intent of ADA (Americans with Disabilities Act) by eliminating the operational requirement “pinch & grasp” motion. The reliable performance and security found within the traditional BEST products is now available in an anti-ligature design.

The tight tolerances, smooth meshing of the lever and the non-moving conical lock escutcheon set the industry standard. As an added suicide resistant measure, the lever is always free-moving bidirectionally, regardless of the lock function. The solid stainless steel design represents the highest level of quality construction found in the industry.

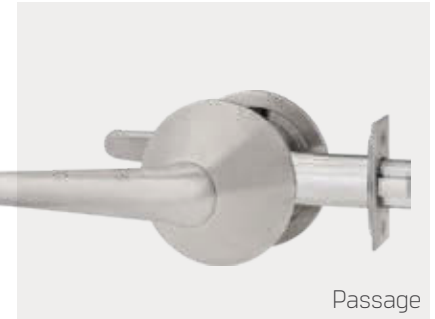

Innovative Ligature-Resistant Features

Designed in collaboration with the nation's largest behavioral healthcare service providers and industry consultants

- Independent, tapered, bidirectional lever
- Thru-bolted fixed conical escutcheon
- Low profile off the door

Durable Design

Proven performance on thousands of applications

- Independent lever springs in escutcheon
- Lever movement stops within escutcheon
- Stainless steel escutcheon and lever
- Fewer moving parts
- Handed
- Accommodates 1 3/4" door thickness

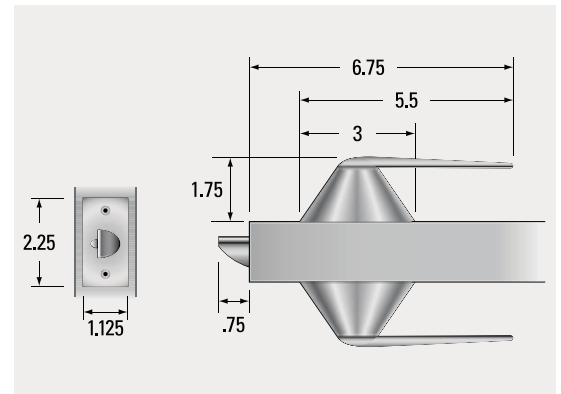

SPSL – Mortise Lock Functions

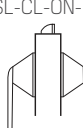
Nomenclature	Behavioral Healthcare Function (Popular usage)	BEST # & Nearest ANSI equivalent	Latch operated by	Element & operating information		
				Outside lever	Interior locking	Inside lever
Keyless						
SPSL-CL-ON-16F 	Passage	ON-Passage FOI	Rotating inside OR outside lever	Cannot be locked	Cylinder	Cannot be locked

How To Order

SPSL	CL	ON	16F	630	RH*	SH
Series	Chassis	Function	Lever	Finish	Hand	Options
SPSL – Secure Patient Safety Lever	CL – Tubular 23/4" backset (69mm) CL5 – Tubular 5" backset (127mm)	ON – Tubular passage	16F – Anti-ligature lever	630 – Satin stainless steel	RH LH RHRB LHRB	SH – Includes security head screws

To ensure proper code compliance, please consult the local AHJ - Authority Having Jurisdiction. *Handed, not field reversible

SSRL – Secure Seclusion Room Lock

Secure Seclusion Room Locks (SSRL) provide effective locking for behavioral health applications requiring temporary patient containment. Single or multi-point bolts protrude into the frame or strike to provide added protection against unauthorized egress attempts. Pending the respective local code requirements, the SSRL can be ordered with features requiring continual or no supervision.

Continuous Supervision: (SSRLS-3, SSRLS-1) Bolts remain extended by facility staff engaging the lever.

No Supervision: (SSRLU-3, SSRLU-1) Bolts remain extended or locked via the lever operation.

Multiple-point locking on the same horizontal plane provides optimal protection from functional wear and/or violent egress attempts. Single-point locking is effective in less severe locations. Unsupervised models require keyed release of the lever lock preventing unauthorized locking of the door.

Retrofit applications, both in-swing and out-swing, are available. Out-swing applications require use of a surface-applied strike plate and mounting plate.

SSRL Feature Summary

- Multi-point deadlocking
- Optional independent or supervised locking
- Stainless steel deadbolts 1" throw
- Surface mounted
- No exposed interior hardware

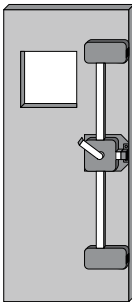
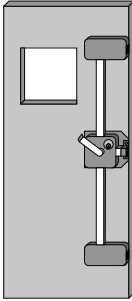

Three Point Models

	<p>SSRLS-3 Constant Supervision Model 3-point w/ lever Application: Behavioral Healthcare, Drug-Substance Abuse or Detention facilities Operation: Lever projects deadbolts; Deadbolts automatically retract when lever is released Please confirm code-compliance prior to ordering or installing</p>	<p>Locksets SSRLS-3 Constant supervision SSRLU-3 Unsupervised</p> <p>Strike SSRL-SK3 Aluminum angled strike kit for 3-point out-swing doors (not packed with lock; must order separately)</p>
	<p>SSRLU-3 Unsupervised Model 3-point w/ lever & cyl. Application: Behavioral Healthcare, Drug-Substance Abuse or Detention facilities Operation: Lever projects / retract deadbolts; Cylinder locks lever Please confirm code-compliance prior to ordering or installing</p>	<p>Options -C Digital Counter (add after model number)</p> <p>HANDING IS REQUIRED Handing is determined by looking at the door from the OUTSIDE of the room and identifying the HINGE side. Strike kits are required for out-swing doors.</p>

Single Point Models

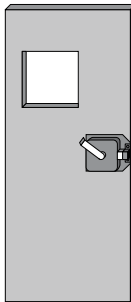
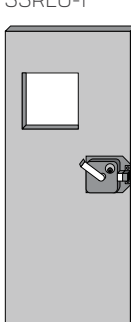
	<p>SSRLS-1 Constant Supervision Model Single point w/ lever Application: Behavioral Healthcare, Drug-Substance Abuse or Detention facilities Operation: Lever projects deadbolts; Deadbolts automatically retract when lever is released Please confirm code-compliance prior to ordering or installing</p>	<p>SSRLS-1 Constant supervision SSRLS-1-SK1 Constant supervision; includes aluminum angled strike for out-swing doors SSRLU-1 Unsupervised SSRLU-1-SK1 Unsupervised; includes aluminum angled strike for out-swing doors</p>
	<p>SSRLU-1 Unsupervised Model 3-point w/ lever & cyl. Application: Behavioral Healthcare, Drug-Substance Abuse or Detention facilities Operation: Lever projects / retract deadbolts; Cylinder locks lever Please confirm code-compliance prior to ordering or installing</p>	<p>SSRL-SK1 Strike kit for single point out-swing doors (may be ordered separately with SSRLS-1 or SSRLU-1) HANDING IS REQUIRED Handing is determined by looking at the door from the OUTSIDE of the room and identifying the HINGE side. Strike kits are required for out-swing doors.</p>

SEDA – Secure Emergency Door Alarm

Secure Emergency Door Alarm's (SEDA) patent-pending full-width door sensor bars are activated by attempts to drape an item over the door. The sensor bar incorporates a curved design providing maximum sensitivity to pressure. The pressure activates internal switches, which are protected by the steel construction. The sensor bars are field adjustable to provide full door coverage and are easily installed.

Retrofit applications are ideal for SEDA. Electrified full-surface continuous hinges have been designed in an anti-ligature fashion and transfer the SEDA signal from the door to the frame. In doing so, coverage over the critical hinge side of the door is maintained. SEDA models may be applied to traditional swinging doors (mounted on pull side of door) or double-acting doors (mounted on patient side of door).

Additional notification and signal monitoring options are available to meet facility requirements. Field adjustments include a nuisance alarm and the piezo volume on the nurse's station console.

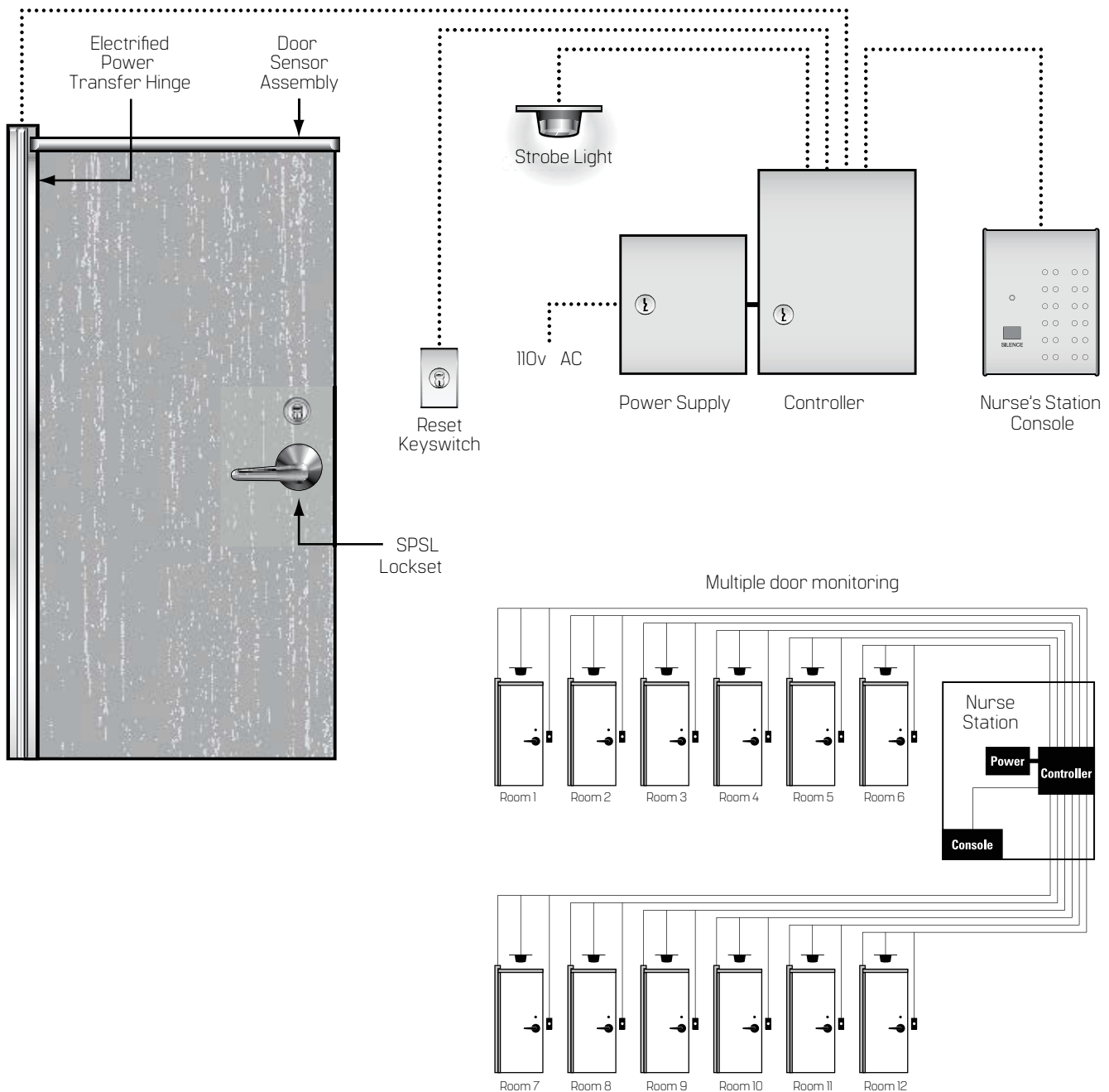

SEDA Elements

Door Sensor Assembly

The Door Sensor Assembly is available with telescoping adjustment to accommodate various door sizes. To avoid inadvertent activation, the DSA is equipped with a field adjustable nuisance delay (factory default 3 seconds). Adjustment setting can be performed at the Controller.

Neutral beige finish. For additional finishes please consult factory.

Door Sensor Assemblies:

SEDA-DSA-P1

- For doors 36" - 42" wide
- Specify PULL SIDE of door width when ordering

SEDA-DSA-P2

- For doors 42" - 48" wide
- Specify PULL SIDE of door width when ordering

SEDA-DSA-P3

- Pair for closet doors up to 36" wide
- Specify PULL SIDE of door width when ordering

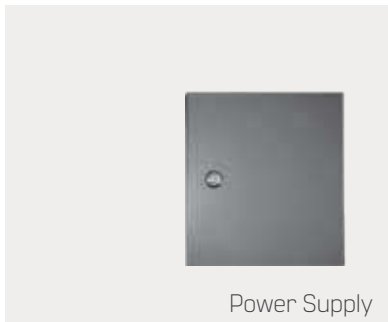

Controller & Power Supply Dimensions:

Model Number	Power Supply Box	Controller Box
SEDA-CPS-1A52-12	8.25H x 7.5W x 3.5D	12.5H x 9.25W x 4.125D
SEDA-CPS-1A52-24	8.25H x 7.5W x 3.5D	15.5H x 11.25W x 4.5D
SEDA-CPS-1A52-36	12.5H x 9.25W x 4.125D	20.25H x 15.5W x 4.25D



Strobe Light:

SEDA-SL2

- Amber strobe light with steel mounting plate

SEDA Elements

Console

The desk mounted console provides remote real-time visual and audible status to the Door Sensor assemblies. Pending the respective opening quantities, the console is available for order to monitor up to 12, 24, or 36 Door Sensor Assemblies.

Console elements:

- LED (1 red/green per room)
- Adjustable piezo alarm
- Remote siren output
- Console output
- Strobe output
- Reset keyswitch inputs
- Power requirements – 12VDC supplied from the controller
- Finishes: Desk Console – Blue case with a beige top. Wall mounted Console - Aluminum cover plate



Desk Console



Wall Mounted Console

Desk Console Dimensions:

Model Number	Dimensions
SEDA-DCRS-12	6.5W x 8.3D x 3 Rear Height x 1.3 Front Height
SEDA-DCRS-24	10W x 8.3D x 3 Rear Height x 1.3 Front Height
SEDA-DCRS-36	14W x 8.3D x 3 Rear Height x 1.3 Front Height

Wall Mounted Console Dimensions:

Model Number	Dimensions
SEDA-WCRS-12	8.25H x 6.25W x 2D
SEDA-WCRS-24	7.25H x 11.25W x 2D
SEDA-WCRS-36	7.25H x 15.25W x 3D

* These dimensions are the install dimensions. The cover plate will cover 1" on the wall around the box.

Reset Keyswitch:

KS101

- Wall mounted keyswitch (single gang box not included)
- 1 1/4" mortise cylinder/straight cam required (cylinder not included)



Reset Keyswitch

Electrified Power Transfer Hinge:

ECHFS-MH-AL-4

- Full-surface angled aluminum construction and finish hinge (security screws provided with hinge)
- Includes header-mounted segment



Electrified Power Transfer Hinge

Accessories:

SEDA-SPLB-1

- Splice box for use within room containing up to 5 doors.



CORPORATE HEADQUARTERS

6161 EAST 75TH STREET
INDIANAPOLIS, IN 46250 USA

Phone 855-365-2407

bestaccess.com

For questions about ordering and to be sure you get the right configuration for your needs, [contact your BEST dormakaba sales representative](#).
6161 East 75th Street, Indianapolis, IN 46250 USA | [855-365-2407](tel:855-365-2407) | bestaccess.com

BEST is a trademark of dormakaba Holding® 2020 All rights reserved. BEST is a member of the dormakaba Group, one of the top three providers for access and security solutions, globally.

