



BEST 
dormakaba Group

8K Series

Heavy Duty Cylindrical Locks – Knobs
by BEST



BEST: Setting the Standard for Security

TABLE OF CONTENTS

Features.....	2	Special Features.....	5
Certification.....	2	Functions.....	6-9
Patents.....	2	CORMAX™ Patented Keying System.....	10
Specifications.....	3	Deadlocking Latches & Strikes.....	10
How To Order.....	3	Door Preparation.....	11
Shipping Weights.....	4	Sample Specifications.....	11
Knob Styles & Trim.....	4	Service Equipment.....	12

8K Series – Features

- Quick, economical rekeying with the BEST® interchangeable core.
- Knobs machined from brass or bronze bar stock.*
- Rotating knob face provides for easy hand of door change without removing the knob.
- No keeper hole on keyed knobs for added security.
- Keyed knob removable only after the core is removed.
- The tactile or knurled knob feature designed for blind, safety and accessibility applications.
- Friction insert inside rose resists loosening.
- The optional breakaway feature prevents the lockset from being overpowered by a wrench.
- 9/16" throw, deadlocking latch.
- Spin free knob feature permits the lock to be operated only by use of a key.
- Steel retractor with low friction bearings for smooth, wear resistant operation.
- Long bearing length in chassis for smooth, wear resistant operation.

* All knob styles feature solid extruded knob material.

Products covered by one or more of the following patents: 5,590,555 5,794,472



8K Heavy Duty Cylindrical

Certification

The 8K Cylindrical Lock meets or exceeds the following standards:

Builders Hardware Manufacturers Association: 8K series – Listed by BHMA for A156.2, Series 4000, Grade 1.

Underwriters Laboratories®: 8K series – Listed by Underwriters Laboratories for use on 3 Hr, A label for single or double swinging doors.

California State Fire Marshal: 8K series – Listed with California State Fire Marshal. Door thickness – Available for 1 3/4" to 2 1/4" doors only. Spacers available for 1 3/8" doors.



Specifications & How to Order

8K Specifications	
Materials	Internal parts are brass or corrosion-treated steel.
Chassis	2 1/16" diameter to fit 2 1/8" hole in door.
Backset	2 3/4" standard, 3 3/4" and 5" available.
Latch	9/16" throw. Front 2 1/4 x 1 1/8" beveled. Latch housing fits 1" hole in edge of door.
Knobs	Diameter – 2 1/8" Projection from door – 2 7/8" #4, #6 Knob Material – Machined from solid brass or bronze.
Roses	All roses are brass or bronze reinforced with steel liner. Roses are threaded to chassis. A – round, 3 3/4" diameter; C – round, 2 9/16" diameter; D – convex round, 3 3/8" diameter E – special trim for 2 1/8" to 3" thick doors
Door Thickness	Adjustable from 1 3/8" to 2" standard. Special "E" trim for 2 1/8" to 3" doors available. The "B" style square trim is for doors 1 3/4" to 2" only.
Strike	[STK] – 2 3/4" x 1 1/8" with curved lip and box standard (ANSI A115.3), [S3] – 4 7/8" x 1 1/4" with curved lip and box available [ANSI A115.2], [S3-7/8] – Conforms to ANSI A115.2 for 1 3/4" doors. [4 7/8" x 1 7/8" flat] STK [standard] – 2 3/4" x 1 1/8" with curved lip & box. [ANSI A115.2 for 1 3/8" doors]. S3 – 4 7/8" x 1 1/4" with curved lip & box. [ANSI A115.2 for 1 3/4" doors].
Latch & Strike Screws	[STK] Strike Package (1) 2 3/4" Strike plate, (4) #8-32 / #8-16 x 3/4" Phillips flat head screws. 8KS3 Strike (1) 4 7/8" Strike plate, (2) #8-32 / #8-16 x 3/4" Phillips flat head screws, (2) #12-24 / #12-12 x 3/4" Phillips flat head screws. Security head machine screws and driver can be ordered for added security.
Finishes	605 – bright brass, clear coated 606 – satin brass, clear coated 611 – bright bronze, clear coated 612 – satin bronze, clear coated 613 – oxidized satin bronze, oil rubbed 625 – bright chromium plated 626 – satin chromium plated; 690 – dark bronze coated

8K Series How To Order

8K	3	7	AB	4	A	STK	626		
Series	Backset	Core Housing	Function Code	Knob Style	Rose Style	Strike Package	Finishes	Options	
8K	3 – 2 3/4" 4 – 3 3/4" 5 – 5"	0 – keyless 7 – 7-pin housing accepts all Best cores	AB – entrance D – storeroom L – privacy N – passage R – classroom etc.	4 – round 6 – tulip	A – 3 3/8" C – 2 9/16" D – convex E – thick (not shown)	STK – standard S3 – ANSI S3 – 7/8" flat strike	605 606 611 612 613 625 626 690	BRK – breakaway (#4, #6) KNL – knurled (#6 knob) LL – lead lined SH – security head screws SPN – spin free (D&W function) (#4, #6 knobs) TAC – tactile knob (#4, #6) Note: specify inside (I), outside (O), or both (B) for KNL, TAC options 3/4 – 3/4" throw latch	
		pages 8–11	page 3	page 3	page 5			page 4	

** Must specify key mark and number of keys or designate L/C for less core.
8KS2 Strike (Standard)

Shipping Weights

The chart below gives the approximate shipping weight for standard functions of 8K lockset. This weight includes the weight of the lockset with the #4 style knob, "A" style rose, latch, strike package, and box. Listed separately are the approximate weights for "with core" and "less core" shipments.

Lock Function Nomenclature	Case Quantity	Shipping Weight With Core	Shipping Weight Less Core
Y	12	36 lbs	36 lbs.
N	12	44 lbs.	44 lbs.
L,NX,P	12	47 lbs.	47 lbs.
AB,D,E,H,HJ,R,T	12	49 lbs.	47 lbs.
C,G,I,N,S,W	12	55 lbs.	51 lbs.

Knob Styles & Trim



Special Features



Breakaway Feature

When excessive force (approx. 300 inch lbs.) is applied to #4, #6 keyed knobs, they "breakaway" and spin freely, thus allowing entrance only by key. Simple part replacement returns lock to functional usage.

To order: Designate "BRK" on options of "How to Order" (page 5).

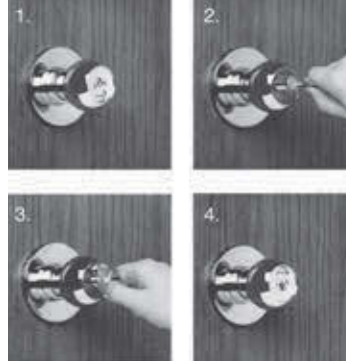

Reversible Knob Face

1. Core is upside down (wrong side)
2. Partially remove core with Control Key.
3. Rotate knob face 180 degrees.
4. Reinsert core with "BEST" in up position. The lockset is easily reversible for either hand of the door without removing the keyed knob.

Knurled Feature

This feature is available only on #6 knob only. The knurling is machined into the outer edge of the knob. The knurled feature can be used for blind, safety or accessibility applications.

To order: Designate "KNL" on options of "How to Order" (page 3).



Tactile Feature

Grooves are machined into the #4 and #6 solid brass or bronze knobs, to improve grip, or can be used as a warning in hazardous areas. This option can be used for blind, safety or accessibility applications.

To order: Designate "TAC" on options of "How to Order" (page 3).



Spin Free Feature

This unique feature is for #4, #6 knobs and is standard on H and HJ functions and optional on D and W. The spin free feature allows the outside knob to spin freely at all times while the core and knob face remain stationary, thus permitting the lock to be operated only by use of a key.

To order: Designate "SPN" on options of "How to Order" (page 3).



Lead Lined Feature

Lead lined can be used to protect against X-rays. Since the majority of lead lined doors contain the lead in the surface of the door, the 8K lockset provides lead lining for the holes cut in the door when preparing the door for the trim. A 3/16" lead slug is installed in the knob face.

To order: Designate "LL" on options of "How to Order" (page 3).



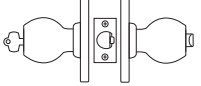
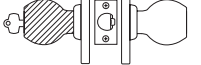
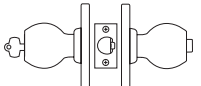
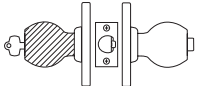
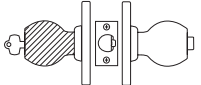
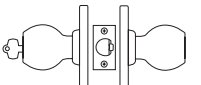
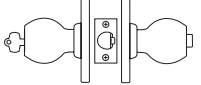
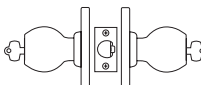
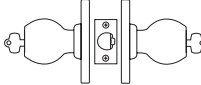

Functions

Description		Outside Lever		Inside Lever	
Function & Diag.(ANSI No.)	Latch operated by	Locked by	Unlocked by	Locked by	Unlocked by
Single keyed					
Entrance (AB) F109 (F81x F82) 	Rotating the inside knob Rotating the outside knob only when the inside push button is out Turning the outside key	Pushing the inside button Pushing and turning the inside button (Turning the button keeps the outside knob locked until button is turned back and released)	Turning the key in the outside knob Rotating the inside knob Closing the door- (only when the button is not turned, this applies for each operation)	Cannot be locked	Always unlocked
Storeroom (D) F86 	Turning the key in the outside knob Rotating the inside knob	Always locked	Cannot be unlocked	Cannot be locked	Always unlocked
Service Station (E) F92 	Rotating the inside knob Rotating the outside knob only when the inside slotted push button is out Turning the key in the outside until button is turned back knob	Pushing the inside button Pushing and turning the inside slotted button (Turning the button keeps the outside knob locked until button is turned back and released)	Turning the key in the outside knob Rotating the inside knob Closing the door- (only when the button is not turned, this applies for each operation)	Cannot be locked	Always unlocked
Hotel Guest Room (H) F93 	Rotating the inside knob Turning the key in the outside knob- only when the inside push button is out Removing the core with a control key and using a special emergency key	Always locked	Key block feature is released by: Rotating the inside knob Closing the door Removing the core with a control key and using a special emergency key	Cannot be locked	Always unlocked
NOTE: Pushing the inside button projects an "occupied" indicator in the outside knob and blocks all operating keys.					
Hotel Guest Room (HJ) 	Rotating the inside knob Turning the key in the outside knob- only when the inside push button is out Removing the core with a control key and using a special emergency key	Always locked	Key block feature is released by: Rotating the inside knob Closing the door	Cannot be locked	Always unlocked
NOTE: Pushing the inside button blocks all operating keys, but no "occupied" indicator is projected.					
Classroom (R) F84 	Rotating the inside knob Turning the key in the outside knob Rotating the outside knob when not locked by key	Turning the key in the outside knob	Turning the key in the outside knob	Cannot be locked	Always unlocked
Dormitory (T) F90 	Rotating the inside knob Rotating the outside knob when not locked by key or push button	Turning the key in the outside knob, Pushing the button on the inside knob	Turning the key in the outside knob Rotating the inside knob (only when locked by push button) Closing the door (only when locked by push button)	Cannot be locked	Always unlocked
Double keyed					
Apartment*(C) F88 	Rotating the inside knob, Rotating the outside knob when not locked by inside key Turning the key in the outside knob	Turning the key in the inside knob	Turning the key in the inside knob	Cannot be locked	Always unlocked
Store lock*(G) F91 	Rotating the outside knob when not locked by key Rotating the inside knob when not locked by key	Turning the key in the inside knob Turning the key in the outside knob	Turning the key in the inside knob Turning the key in the outside knob	Turning the key in the inside knob Turning the key in the outside knob	Turning the key in the inside knob Turning the key in the outside knob
NOTE: Turning the key in either the inside OR the outside, locks or unlocks both sides					

*ATTENTION: Locksets that secure both sides of the door are controlled by building codes and the Life Safety Code. In an emergency exit situation, failure to quickly unlock the inside knob could be hazardous or even fatal.

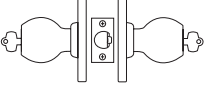
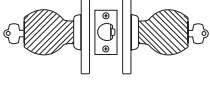
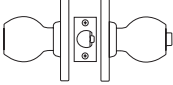
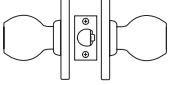
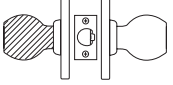
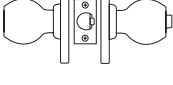
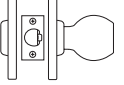
Functions

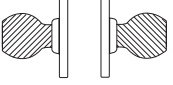
Function & Diag.(ANSI No.)	Description	Outside Lever		Inside Lever	
		Locked by	Unlocked by	Locked by	Unlocked by
Double keyed (Continued)					
Communicating * (S) F80 	Turning the key in the inside knob Turning the key in the outside knob Rotating the inside or outside knob (if unlocked) NOTE: Turning the key in either knob, locks or unlocks its own knob independently.	Turning the key in the outside knob	Turning the key in the outside knob	Turning the key in the inside knob	Turning the key in the inside knob
Institutional * (W) F87 	Turning the key in the inside knob Turning the key in the outside knob	Always locked	Cannot be unlocked	Always locked	Cannot be unlocked
Keyless					
Privacy (L) F76 	Rotating the inside knob Rotating the outside knob only when the inside push button is out	Pushing the inside button	Rotating the outside slotted button Rotating the inside knob Closing the door	Cannot be locked	Always unlocked
Passage (N) F75 	Rotating the inside knob Rotating the outside knob	Cannot be unlocked	Always unlocked	Cannot be locked	Always unlocked
Exit (NX) F89 	Turning the inside knob	Always locked	Cannot be unlocked	Cannot be locked	Always unlocked
Patio (P) F77 	Rotating the inside knob Rotating the outside knob only when the inside push button is out	Pushing the inside button Closing the door	Rotating the inside knob	Cannot be locked	Always unlocked
Exit (Y) 	Rotating the inside knob		Cannot be locked	Always Unlocked	
Single Dummy Trim (1DT) 	This is a single, surface-mounted knob for an inactive door or a non-latching door				
Double Dummy Trim (2DT) 	This is a through-bolt mounted pair of matching knobs for an inactive door or a non-latching door				

*ATTENTION: Locksets that secure both sides of the door are controlled by building codes and the Life Safety Code. In an emergency exit situation, failure to quickly unlock the inside knob could be hazardous or even fatal.

Functions

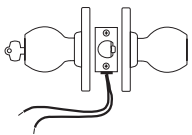
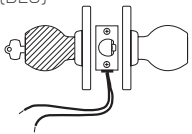
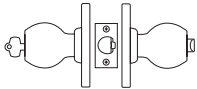
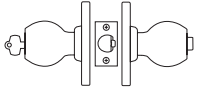
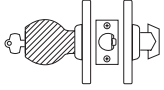
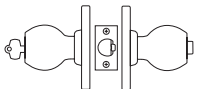
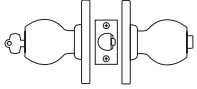
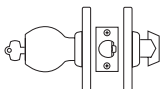
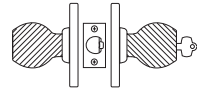
Description		Outside Lever		Inside Lever	
Function & Diag.(ANSI No.)	Latch operated by	Locked by	Unlocked by	Locked by	Unlocked by
Electrified					
Electrically Locked (DEL) 	Rotating the inside knob Rotating the outside knob only when power is off Turning the key in the outside knob NOTE: Locks are powered by 24 Volts DC and 0.18 Amps, continuous duty.	Applying 24 Volts DC; the outside knob remains locked only while power is on	Switching off 24 Volts DC	Cannot be locked	Always unlocked
Electrically Unlocked (DEU) 	Rotating the inside knob Rotating the outside knob only when power is on Turning the key in the outside knob NOTE: Locks are powered by 24 Volts DC and 0.18 Amps, continuous duty.	Switching off 24 Volts DC	Applying 24 Volts DC; the outside knob remains unlocked only while power is on	Cannot be locked	Always unlocked
Special functions					
Dormitory or Storeroom (A) F81 	Rotating the inside knob Rotating the outside knob only when inside turn button is in unlocked position Turning the key in the outside knob	Turning the inside button	Turning the inside button	Cannot be locked	Always unlocked
Office (B) F82 	Rotating the inside knob Rotating the outside knob only when inside push button is out Turning the key in the outside knob NOTE: Push button is released by turning the key in the outside knob, OR rotating the inside knob. Closing the door does not release the push button.	Pushing the inside button outside knob, Rotating the inside knob	Turning the key in the outside knob	Cannot be locked	Always unlocked
Closet or Storeroom (DZ) 	Turning the key in the outside knob Turning the inside closet turn knob	Always locked	Cannot be unlocked	Closet turn knob cannot be locked	Closet turn knob always unlocked
Entrance or Office (EA) 	Rotating the inside knob, Rotating the outside knob only when inside push button is out Turning the key in the outside knob *Only when slotted button depressed and not turned.	Pushing inside button Pushing and turning the inside button (Turning slotted button keeps the outside knob locked until the button is turned back	Turning the key in the outside knob* Rotating the inside knob* Closing the door*	Cannot be locked	Always unlocked
Dormitory (T) F90 	Rotating the inside knob Rotating the outside knob when not locked by key or push button	Turning the key in the outside knob Pushing the button on the inside knob	Turning the key in the outside knob Rotating the inside knob (only when locked by push button) Closing the door (only when locked by push button)	Cannot be locked	Always unlocked
Closet or Storeroom (RZ) 	Turning the key in the outside knob Turning the inside closet turn knob Turning the outside knob when unlocked by key	Turning the key in the outside knob	Turning the key in the outside knob	Closet turn knob cannot be locked	Closet turn knob always unlocked
Special* (XD) 	Turning the key in the inside knob	Always locked	Cannot be unlocked	Always locked	Cannot be unlocked

*ATTENTION: Locksets that secure both sides of the door are controlled by building codes and the Life Safety Code. In an emergency exit situation, failure to quickly unlock the inside knob could be hazardous or even fatal.

Functions

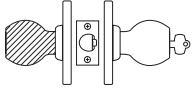
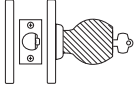
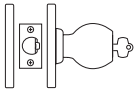
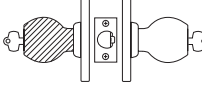
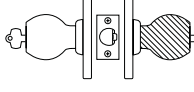
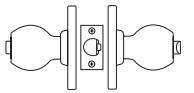
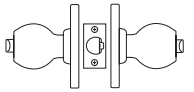
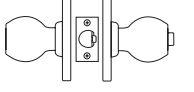
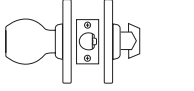
Description		Outside Lever		Inside Lever	
		Locked by	Unlocked by	Locked by	Unlocked by
Function & Diag.(ANSI No.)	Latch operated by				
Special functions					
Special* (XR) 	Turning the key in the inside knob Rotating the inside knob when not locked by key	Always locked	Cannot be unlocked	Turning the key in the inside knob	Turning the key in the inside knob
Exit* (YD) 	Turning the key in the inside knob	N/A	N/A	Always locked	Cannot be unlocked
Special* (YR) 	Turning the key in the inside knob Rotating the inside knob when not locked by key	N/A	N/A	Turning the key in the inside knob	Turning the key in the inside knob
Special* (DR) 	Rotating the inside knob when unlocked by inside key, Turning the key in the outside knob Turning the key in the inside knob	Always locked	Cannot be unlocked	Turning the key in the inside knob	Turning the key in the inside knob
Special* (RD) 	Rotating the outside knob Turning the key in the outside knob Turning the key in the inside knob	Turning the key in the outside knob	Turning the key in the outside knob	Always locked	Cannot be unlocked
Hospital Privacy (LL) 	Rotating the inside knob Rotating the outside knob only when the inside push button is out	Pushing the inside button	Turning the turn button in the outside knob Rotating the inside knob Closing the door	Cannot be locked	Always unlocked
Communicating* (M) F78 	Rotating the inside knob only when the outside turn button is in the unlocked position Rotating the outside knob only when inside turn button is in the unlocked position NOTE: Do not use this function for rooms that have no other entrance.	Turning the inside turn button	Turning the inside turn button	Turning the outside turn button	Turning the outside turn button
Exit (O) F83 	Rotating the inside knob Rotating the outside knob only when the inside turn button is in the unlocked position	Turning the inside turn button	Turning the inside turn button	Cannot be locked	Always unlocked
Closet (Z) 	Rotating the outside knob, Turning the inside closet turn knob	Cannot be locked	Always unlocked	Closet turn knob cannot be locked	Closet turn knob cannot be locked

*ATTENTION: Locksets that secure both sides of the door are controlled by building codes and the Life Safety Code. In an emergency exit situation, failure to quickly unlock the inside knob could be hazardous or even fatal.

CORMAX™ Patented Keying System

BEST® CORMAX™ is the premier patented keying system offered by BEST. CORMAX will meet your needs for security, key control, and convenience. A simple solution with no compromising allowed. CORMAX is the upgrade path for existing BEST Standard, Premium, and MX8 customers; and it is an essential element of non-residential access control as security administrators strive to eliminate the unauthorized duplication of keys.

CORMAX offers the following features and benefits:

- A long-term US utility patent that guarantees the extended useful life of the system through 2027.
- A second, independent locking mechanism that utilizes a patented set of built-in side pins to provide higher security.
- Several levels of geographical exclusivity, including national exclusivity, are available via the patented side pin feature.
- CORMAX cores and keys are available exclusively through BEST sales offices. Key blanks are only sold to individuals authorized by the customer to ensure key blanks do not end up in the possession of unauthorized personnel either inside or outside the customer's facility.
- CORMAX cores™ are certified to meet the security, safety, and reliability requirements of BHMA A156.5 Grade 1.
- Picking and drilling resistance options are available if higher levels of security are desired.
- Complete factory masterkeying service offered, and at no charge with purchase of BEST locksets and PHI exit devices.
- Keyways are organized in families of four keyways each, with double-milled and quad-milled key levels to facilitate the design of masterkey systems in multi-building campuses.
- BEST CORMAX cores are compatible with all existing BEST interchangeable core housings, eliminating the need for new or modified locksets.



Deadlocking Latches & Strikes

8KL3 Deadlocking Latch

Bolt throw: 9/16"

Backset: 2 3/4"

Front: 2 1/4" x 1 1/8" beveled

Tube: To fit 1" diameter hole in door edge

To order: (with unit) designate "9K3" on How to Order (page 3).

To order: (without unit) designate "8KL3-SL" (Spring Latch) or DL (Deadlocking Latch) and finish.



8KL4 Deadlocking Latch

Bolt throw: 9/16"

Backset: 3 3/4"

Front: 2 1/4" x 1 1/8" beveled

Tube: To fit 1" diameter hole in door edge

To order: (with unit) designate "9K4" on How to Order (page 3).

To order: (without unit) designate "8KL4-SL" (Spring Latch) or DL (Deadlocking Latch) and finish.



8KL5 Deadlocking Latch

Bolt throw: 9/16"

Backset: 5"

Front: 2 1/4" x 1 1/8" beveled

Tube: To fit 1" diameter hole in door edge

To order: (with unit) designate "9K5" on How to Order (page 3).

To order: (without unit) designate "8KL5-SL" (Spring Latch) or DL (Deadlocking Latch) and finish.



8KS3-7/8 Flat Strike

Dimension: Conforms to ANSI A115.2 for 1 3/4" doors (4 7/8" x 1 7/8" flat)

To order: (with unit) designate "S3-7/8" on How to Order (page 3).

To order: (without unit) designate 8KS3-7/8 and finish.



8KS3 Strike

Dimension: Conforms to ANSI A115.2 for 1 3/4" doors (4 7/8" x 1 1/4" with curved lip).

To order: (with unit) designate "S3" on How to Order (page 3).

To order: (without unit) designate 8KS3 and finish.



8KS2 Strike (Supplied Standard)

Dimension: Conforms to ANSI A115.2 for 1 3/8" doors (2 3/4" x 1 1/8" with curved lip and box)

To order: (with unit) designate "STK" on How to Order (page 3).

To order: (without unit) designate 8KS2 and finish.



Strikes & Door Preparation

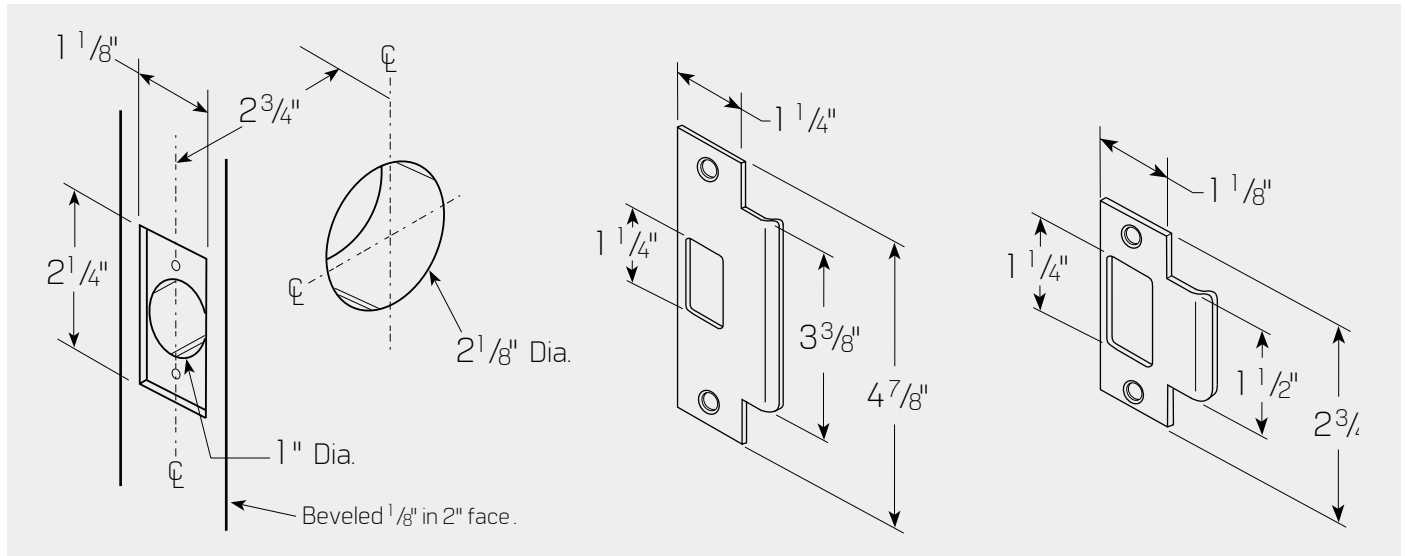

Sample Specifications - Acceptable Manufacturers

A. Locksets and Latchsets

BEST - No Substitution.

1. Locksets must be extra heavy-duty cylindrical type with 2 3/4 inch backset, or greater as specified, with a 9/16 inch throw latchbolt.
2. Provide locksets with BEST® 7-pin interchangeable core.
3. Locksets and latchsets must conform to ANSI A156.2, Series 4000, Grade 1, and be UL listed.
4. Locksets and cores to be of the same manufacturer to maintain complete lockset warranty.
5. Locksets must be available with tactile or abrasive lever for identification of hazardous areas.
6. Locks to have solid shank with no opening for access to keyed lever keeper.
7. Keyed lever to be removable only after core is removed, by authorized control key, to allow access to lever "keeper".
8. Permanent core face must be the same finish as the lockset finish.
9. Levers must have a minimum wall thickness of .060.

B. Keys and Keying

- A. Provide construction cores and keys during the construction period. Construction, control and operating keys and cores shall not be part of the Owner's permanent keying system or furnished on the same keyway as the Owner's permanent keying system. Permanent cores and keys prepared according to the accepted keying schedule will be furnished to the Owner by the local BEST office prior to occupancy. The Owner or Owner's agent will install permanent cores and return the construction cores to the BEST office.

- B. All cylinders shall be BEST 7-pin, interchangeable core and keyed into a [new] [existing] factory registered Grand Master Key System with a restricted keyway.
- C. Permanent keys and cores shall be stamped with the applicable key mark for identification. These visual key control marks or codes will not include the actual key cuts. Permanent keys will also be stamped ["Do Not Duplicate."] ["US. Gov.-Do Not Duplicate."] [_____]
- D. Grand Masterkeys, Masterkeys and other Security Keys shall be transmitted to the Owner by U.P.S., delivery confirmation requested.
- E. Furnish keys in the following quantities:
 - 1 each Grand Masterkey
 - 2 each Construction masterkeys
 - 2 each Masterkeys per set
 - 2 each Control keys
 - 1 each Change key per each keyed core
- F. Computer key and core control software BEST Keystone® 600N5 will be provided and registered to the owner by the local BEST office. The owner will furnish compatible hardware to operate the key and core control program. The BEST office will provide initial training on computer key and core control as well as on-going support including software updates.

Service Equipment

KD304A Boring Jig Kit

The KD304A jig kit is made for boring cut-outs in wooden doors for Fed. Spec. 160 and 161 series cylindrical/tubular locksets, doors 1 3/8" to 2 1/4" thick. The KD304A kit includes the boring jig (to drill wood doors for 2 3/8", 2 3/4", 3 3/4", and 5" backsets), a quick-release adaptor for 3/8" drill chuck, a 2 1/8" bit, and a 1" diameter x 9" bit.



KD304A parts



KD304A with case

The following kit items can also be purchased separately.

KD309 – 2 1/8" bit

KD318 – 1" dia. x 9" bit

KD319 – 3/8", quick release adaptor

To order complete kits specify: KD304A Kit

KD312 and KD315 Face Plate Marking Chisel and KD325 Strike Plate Location Pin

The KD315 face plate marking chisel (which locates the mortising for the faceplate) and the KD325 strike locating pin (which centers the strike for proper installation) and is used for Fed. Spec. 161 cylindrical lockset, (1 1/8" x 2 1/8"), and BEST® series 82T & 83T tubular locks. The KD312 face plate marking chisel is available for Fed. Spec. 160 (1" x 2 1/4") preparation.

To order specify: KD312– face plate marking chisel 1" (160)

KD315– face plate marking chisel 1 1/8" (161)

KD325– strike plate locating pin



KD315 [Fed. Spec. 161]



KD325



KD316

KD 316 Spanner Wrench

All 8K locksets require the use of the KD316 spanner wrench for door mounting. This tool is included with every 10 locksets ordered. If more are needed designate quantity and KD316 on your order.

Mortise-to-Cylindrical Lock Adaptor Kit

Mortise lock mounting may be converted to BEST® cylindrical lock through use of this kit.



83KA2A

One-Piece Universal Mortise/Cylindrical-to-Cylindrical Adaptor Kit

Door previously mounted with another manufacturer's lockset may be quickly adapted to a BEST® cylindrical lock through use of the following kit.



83KA2B

Specifications	
Materials	Stainless steel
Finish	630 only
Escutcheon	3 1/2" x 8 1/2" x .050" thickness
Strike	1 1/2" x 8" with 6 3/4" lip, 1 1/4" to center
Face Plate	83KF1–8" x 1 1/8" wide
Backset	2 3/4" Door thickness is increased 7/64" for mounting 83K series locksets
To order specify	Adaptor kit 83KA2A kit

Specifications	
Materials	Stainless steel
Finish	630 only
Face Plate Recess	2 1/4" x 1 1/8"
Backset	2 3/4"
Door Thickness	1 3/4"
To order specify	83KA2B

For questions about ordering and to be sure you get the right configuration for your needs, [contact your BEST dormakaba sales representative](#).
6161 East 75th Street, Indianapolis, IN 46250 USA | [855-365-2407](tel:855-365-2407) | bestaccess.com