



BEST 
dormakaba Group

7KC Series
Medium Duty Cylindrical Locks
by BEST



TABLE OF CONTENTS

Features	2	Cormax™ Patented Keying System	5
Specifications	2	Deadlocking Latches & Strikes	5-6
How To Order	3	Strikes & Door Preparation	6
Shipping Weights	3	Sample Specifications	7
Lever Styles & Trim	3	Service Equipment	7
Functions	4		

7KC Series – Features

- Cylindrical chassis to fit common door preparation.
- Standard and Drive-in latches available.
- Through-bolt mounting studs increase torque resistance.
- Quick rekeying with BEST interchangeable core.
- No exposed keeper hole on keyed levers for increased security.
- Hub torque spring provides extra resistance to lever sag.
- Snap-on inside rose (no exposed mounting screws).
- Keyed lever is removable only after removal of core.
- Internal steel mechanisms are corrosion treated for normal atmospheric conditions.
- ADA–Americans With Disabilities Act: 7KC series – The design and operation of the BEST® cylindrical lock meets the intent of the standard for ANSI A117.1 section 404.2.6 and Illinois Accessibility Standard 400.310 (j)(8).
- Lockset reversible for either hand of door without removing keyed lever.
- Underwriters Laboratories®: 7KC series – Listed by Underwriters Laboratories for use on 3 Hr, A label for single (4' x 8') doors.
- Builders Hardware Manufacturers Association: 7KC series – Listed by BHMA for A156.2, Series 4000, Grade 2.
- ADA–Americans With Disabilities Act: 7KC series – The design and operation of the BEST® cylindrical lock meets the intent of the standard for ANSI A117.1 section 404.2.6 and Illinois Accessibility Standard 400.310 (j)(8).
- California State Fire Marshal: 7KC - series 14 & 15 lever conforms with California Title 24.

Products covered by one or more of the following patents: 5,590,555 5,794,472

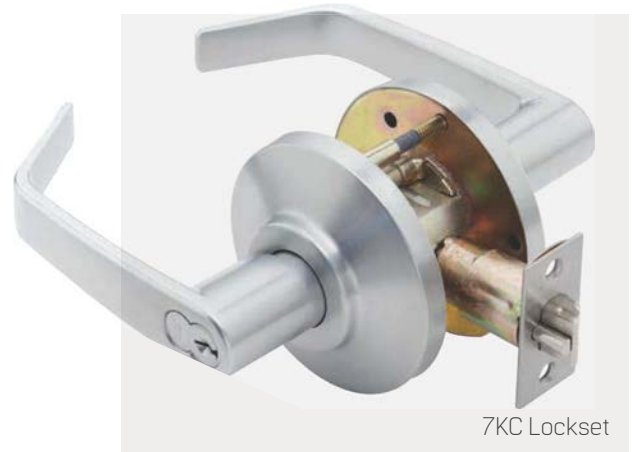

Specifications		
Backset	7KC2 Series: 2 3/8" 7KC3 Series: 2 3/4"	7KC4 Series: 3 3/4" 7KC5 Series: 5"
Finishes	605 – bright bras 606 – satin bras 612 – satin bronze	613 – oxidized satin bronze, oil rubber 625 – bright chromium plate 626 – satin chromium plated
Interchangeable core	Solid brass, pin-tumbler type in lever with 7-pin core. BEST Patented Keying System optional.	
Latch	1/2" throw deadlocking latch. Front: 2 1/4" x 1 1/8" x 5/32" standard for 2 3/4" backset; 2 1/4" x 1" x 5/32" for 2 3/8" backset.	
Lever	5 1/4" long handle with return. Projection on door 2 1/2". Zinc base, plated to match finish.	
Material	Component parts include brass, bronze or zinc. Internal parts are zinc dichromate steel.	
Mounting	2 1/8" diameter bore for lock housing, 1" diameter for latch tube.	
Rose	D – 3 1/2" diameter mounting screws concealed.	
Strike	STK (standard) – 2 3/4" x 1 1/8" with curved lip & box. (ANSI A115.2 for 1 3/8" doors). S3 – 4 7/8" x 1 1/4" with curved lip & box. (ANSI A115.2 for 1 3/4" doors).	
Door thickness	1 3/8" to 2"	

NOTE: When a heavy duty cylindrical lockset is required, our heavy duty 9K series is recommended.

7KC Series How To Order

7KC	3	7	AB	15	D	STK	626	
Series	Backset	Core Housing	Function Code	Lever	Trim Style	Strike Package	Standard Finishes	Options
7KC	2 – 2 3/8" 3 – 2 3/4" 4 – 3 3/4" 5 – 5"	0 – keyless 7 – 7-pin housing accepts all Best cores	AB – entrance D – storeroom L – privacy N – passage R – classroom Y – exit IDT – dummy exit	♿.14 – curved return ♿.15 – contour angle return ♿.16 – curved no return	D – 3 1/2"	STK – standard S3 – ANSI	605 606 612 613 625 626	L8* – drive in-latch SCH** – non-IC schlage

* Available on 2 3/8" and 2 3/4" backsets only.

** Available in #15 lever only. Cylinder not included.

Shipping weights

The chart is the approximate shipping weight for the standard 7KC functions locksets. This weight includes the weight of the lockset with the "#15" style lever, "D" style rose, latch, strike package, and box. Listed separately are the approximate weights for "with core" and "less core" shipments.

Lock Function Nomenclature	Case Quantity	Shipping Weight With Core	Shipping Weight Less Core
Y	9		31 lbs.
N	9		40 lbs.
L	9		40 lbs.
AB, D, R	9	42 lbs.	40 lbs.

Lever styles & trim

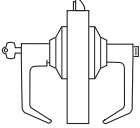
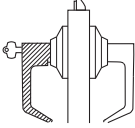
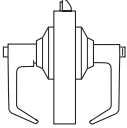
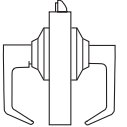
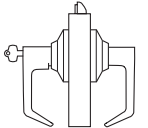
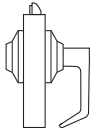
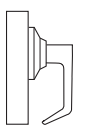

Functions

Function & Diag. (ANSI No.)	Description	Outside Lever		Inside Lever	
		Latched by	Locked by	Unlocked by	Locked by
Single keyed					
Entry (AB) F109-Grade 2 	Rotating inside lever Rotating the outside lever – only when the inside push button is out Turning key in outside lever	Pushing the inside button Pushing and turning the inside button. Turning the button keeps the outside lever locked until the button is turned back	Turning the key in the outside lever (only when the button is not turned) Rotating the inside lever (only when the button is not turned) Closing the door (only when the button is not turned)	Cannot be locked	Always Unlocked
Storeroom (D) F86-Grade 2 	Turning key in the outside lever Rotating inside lever	Always locked	Cannot be unlocked	Cannot be locked	Always Unlocked
Privacy (L) F76-Grade 2 	Rotating inside lever Rotating outside lever – only when inside push button is out	Pushing inside button	Rotating the outside slotted button Rotating the inside lever, Closing the door	Cannot be locked	Always Unlocked
Passage (N) F75-Grade 2 	Rotating inside lever Rotating outside lever	Cannot be unlocked	Always unlocked	Cannot be locked	Always Unlocked
Classroom (R) F84-Grade 2 	Rotating inside lever Turning key in outside lever when outside lever is locked Rotating outside lever when not locked by key	Turning key in outside lever	Turning key in outside lever	Cannot be locked	Always Unlocked
Exit (Y) Grade 2 	Rotating the inside lever	No outside lever - Blank rose	No outside lever - Blank rose	Cannot be locked	Always Unlocked
Single Dummy (IDT) Grade 2 	This is a single, surface-mounted lever for an inactive door or a non-latching door				

CORMAX™ Patented Keying System

BEST® CORMAX™ is the premier patented keying system offered by BEST. CORMAX will meet your needs for security, key control, and convenience. A simple solution with no compromising allowed. CORMAX is the upgrade path for existing BEST Standard, Premium, and MX8 customers; and it is an essential element of non-residential access control as security administrators strive to eliminate the unauthorized duplication of keys.

CORMAX offers the following features and benefits:

- A long-term US utility patent that guarantees the extended useful life of the system through 2027.
- A second, independent locking mechanism that utilizes a patented set of built-in side pins to provide higher security.
- Several levels of geographical exclusivity, including national exclusivity, are available via the patented side pin feature.
- CORMAX cores and keys are available exclusively through BEST sales offices. Key blanks are only sold to individuals authorized by the customer to ensure key blanks do not end up in the possession of unauthorized personnel either inside or outside the customer's facility.
- CORMAX cores are certified to meet the security, safety, and reliability requirements of BHMA A156.5 Grade 1.
- Picking and drilling resistance options are available if higher levels of security are desired.
- Complete factory masterkeying service offered, and at no charge with purchase of BEST locksets and PHI exit devices.
- Keyways are organized in families of four keyways each, with double-milled and quad-milled key levels to facilitate the design of masterkey systems in multi-building campuses.
- BEST CORMAX cores are compatible with all existing BEST interchangeable core housings, eliminating the need for new or modified locksets.



Deadlocking Latches & Strikes

62KCL2 Deadlocking Latch Specifications

Bolt throw: 1/2"

Backset: 2 3/8"

Front: 2 1/4" x 1" beveled

Tube: To fit 1" diameter hole in door edge

To order: (with unit) designate "72KC"

To order: (without unit) designate "72KCL2"



63KCL3 Deadlocking Latch Specifications

Bolt throw: 1/2"

Backset: 2 3/4"

Front: 2 1/4" x 1 1/8" beveled

Tube: To fit 1" diameter hole in door edge

To order: (with unit) designate "73KC"

To order: (without unit) designate "73KCL3"



64KL4 Deadlocking Latch Specifications

Bolt throw: 1/2"

Backset: 3 3/4"

Front: 2 1/4" x 1 1/8" beveled

Tube: To fit 1" diameter hole in door edge

To order: (with unit) designate "64K"

To order: (without unit) designate "64KL4"



65KL5 Deadlocking Latch Specifications

Bolt throw: 1/2"

Backset: 5"

Front: 2 1/4" x 1" beveled

Tube: To fit 1" diameter hole in door edge

To order: (with unit) designate "65K"

To order: (without unit) designate "65KL5"



65KL5

6KS2 Strike (Supplied Standard) Specifications

Dimensions: Conforms to ANSI A115.2 for 1 3/8" doors (2 3/4" x 1 1/8" with curved lip and box)

To order: (with unit) designate "STK"

To order: (without unit) designate "6KS2" and finish



6KS2

6KS3 Strike (ANSI Strike) Specifications

Dimensions: Conforms to ANSI A115.2 for 1 3/4" doors (4 7/8" x 1 1/8" with curved lip)

To order: (with unit) designate "S3"

To order: (without unit) designate "6KS3" and finish



6KS3

Strikes & Door Preparation

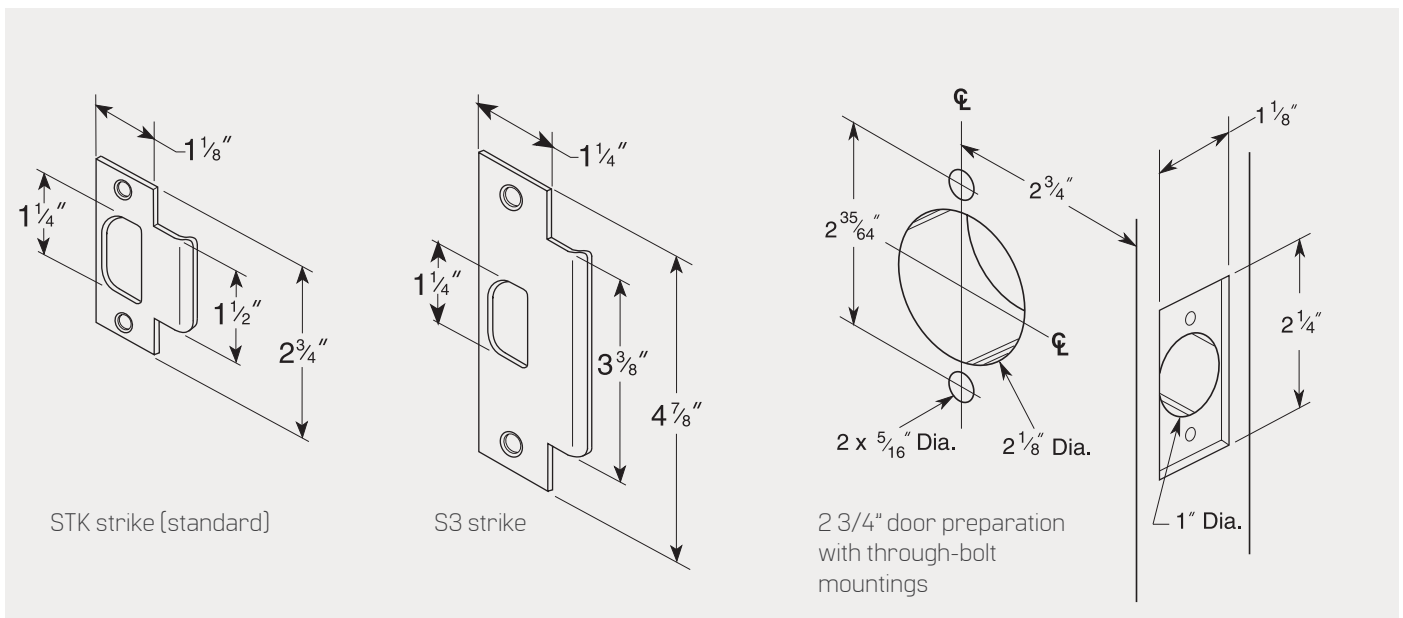

Sample Specifications - Acceptable Manufacturers

A. Locksets and Latchsets

BEST - No Substitution.

1. Locksets must be extra heavy-duty cylindrical type with 2 3/4 inch backset, or greater as specified, with a 9/16 inch throw latchbolt.
2. Provide locksets with BEST® 7-pin interchangeable core.
3. Locksets and latchsets must conform to ANSI A156.2, Series 4000, Grade 1, and be UL listed.
4. Locksets and cores to be of the same manufacturer to maintain complete lockset warranty.
5. Locksets must be available with tactile or abrasive lever for identification of hazardous areas.
6. Locks to have solid shank with no opening for access to keyed lever keeper.
7. Keyed lever to be removable only after core is removed, by authorized control key, to allow access to lever "keeper".
8. Permanent core face must be the same finish as the lockset finish.
9. Levers must have a minimum wall thickness of .060.

B. Keys and Keying

- A. Provide construction cores and keys during the construction period. Construction, control and operating keys and cores shall not be part of the Owner's permanent keying system or furnished on the same keyway as the Owner's permanent keying system. Permanent cores and keys prepared according to the accepted keying schedule will be furnished to the Owner by the local BEST office prior to occupancy. The Owner or Owner's agent will install permanent cores and return the construction cores to the BEST office.

- B. All cylinders shall be BEST 7-pin, interchangeable core and keyed into a [new] [existing] factory registered Grand Master Key System with a restricted keyway.
- C. Permanent keys and cores shall be stamped with the applicable key mark for identification. These visual key control marks or codes will not include the actual key cuts. Permanent keys will also be stamped ["Do Not Duplicate."] ["U.S. Gov.-Do Not Duplicate."] [_____]
- D. Grand Masterkeys, Masterkeys and other Security Keys shall be transmitted to the Owner by U.P.S., delivery confirmation requested.
- E. Furnish keys in the following quantities:
 - 1 each Grand Masterkey
 - 2 each Construction masterkeys
 - 2 each Masterkeys per set
 - 2 each Control keys
 - 1 each Change key per each keyed core
- F. Computer key and core control software BEST Keystone® 600N5 will be provided and registered to the owner by the local BEST office. The owner will furnish compatible hardware to operate the key and core control program. The BEST office will provide initial training on computer key and core control as well as on-going support including software updates.

Cylindrical Locks Service Equipment

KD304A Boring Jig Kit

The KD304A jig kit is made for boring cut-outs in wooden doors for Fed. Spec. 160 and 161 series cylindrical/tubular locksets, doors 1 3/8" to 2 1/4" thick. The KD304A kit includes the boring jig (to drill wood doors for 2 3/8", 2 3/4", 3 3/4", and 5" backsets), a quick-release adaptor for 3/8" drill chuck, a 2 1/8" bit, and a 1" diameter x 9" bit.

The following kit items can also be purchased separately.

KD309 – 2 1/8" bit

KD318 – 1" dia. x 9" bit

KD319 – 3/8", quick release adaptor

To order complete kits specify: KD304A Kit

KD312 and KD315 Face Plate Marking Chisel and KD325 Strike Plate Location Pin The KD315 face plate marking chisel (which locates the mortising for the faceplate) and the KD325 strike locating pin (which centers the strike for proper installation) and is used for Fed. Spec. 161 cylindrical lockset, (1 1/8" x 2 1/8"), and BEST® series 82T & 83T tubular locks. The KD312 face plate marking chisel is available for Fed. Spec. 160 (1" x 2 1/4") preparation.

To order specify: KD312– face plate marking chisel 1" (160)
 KD315– face plate marking chisel 1 1/8" (161)
 KD325– strike plate locating pin



KD304A parts



KD304A with case



KD315 (Fed. Spec. 161)



KD325



CORPORATE HEADQUARTERS

6161 EAST 75TH STREET
INDIANAPOLIS, IN 46250 USA

Phone 855-365-2407

bestaccess.com

For questions about ordering and to be sure you get the right configuration for your needs, [contact your BEST dormakaba sales representative.](#)
6161 East 75th Street, Indianapolis, IN 46250 USA | [855-365-2407](tel:855-365-2407) | bestaccess.com

BEST is a trademark of dormakaba Holding® 2020 All rights reserved. BEST is a member of the dormakaba Group, one of the top three providers for access and security solutions, globally.

dormakaba 

BA-0026 04/21